



## Burner Controls

**LOK16...  
LGK16...**

---

### Burner controls

- With self-checking flame signal amplifier
- For continuously operating multistage or modulating oil or gas burners of medium to high capacity
- With air pressure supervision for checked air damper control.

The LOK16... / LGK16... and this Data Sheet are intended for use by OEMs which integrate the burner controls in their products.

## Use

---

Burner controls type LOK16... / LGK16... feature a self-checking flame supervision circuit.

The supervision circuit initiates the required safety actions not only in the case of premature or missing flame signals, but also in the event of any kind of fault on the flame detector, the detector cables or the flame signal amplifier that could simulate a flame signal during burner operation.

The burner controls are therefore suited for use in all types of oil- or gas-fired combustion plant where self-checking flame supervision systems are either mandatory or recommended:

- Burners that operate continuously
- Burners in intermittent operation that, in the case of great heat demand, may operate continuously for more than 14 hours, e.g. in plant using boiler sequencing
- Burners that need to comply with the German TRD 411 and TRD 412 regulations for steam boilers
- Burners in plant where, for specific safety requirements, supervision of the burner by a self-checking flame supervision system seems advisable
- The control sequence and connection circuitry of the LOK16... / LGK16... burner controls are identical to those of the LAL2... and LFL1... respectively (with the exception of the LFL1.148), so that existing combustion plant can also be equipped with self-checking burner controls,
  - provided very good flame detector current values are measured in the plant supervised so far by the LFL1..., and
  - provided the following types of flame detectors are either installed or can subsequently be fitted:

Flame supervision  
when using LOK16...

- Selenium photocell detector RAR...

Flame supervision  
when using LGK16...

- Flame detector QRA53... / QRA55...
- Ionization probe
- Flame detector QRA53... / QRA55... together with ionization probe, e.g. in the case of burners using a pilot burner (also refer to Data Sheet N7712)

## Warning notes

---



**To avoid injury to persons, damage to property or the environment, the following warning notes should be observed!**

**Do not open, interfere with or modify the unit!**

- All activities (mounting, installation and service work, etc.) must be performed by qualified staff
- Before performing any wiring changes in the connection area of the LOK16... / LGK16..., completely isolate the burner control from the mains supply (all-polar disconnection)
- Ensure protection against electric shock hazard by providing adequate protection for the burner control's connection terminals
- Check to ensure that wiring is in an orderly state
- Press the lockout reset button only manually (applying a force of no more than 10 N) without using any tools or pointed objects
- **Do not press the lockout reset button on the unit or the remote reset button (input 21) for more than 10 seconds, since this would damage the lockout relay inside the unit**
- Fall or shock can adversely affect the safety functions. Such units must not be put into operation, even if they do not exhibit any damage

## Mounting notes

---

Ensure that the relevant national safety regulations are complied with.

### Upgrading existing plant

When converting plant to LOK16... or LGK16..., the existing LAL... or LFL... base must be secured by a cylinder-shaped grooved pin, thus ensuring that only an LOK16... or LGK16... type burner control can be fitted.

Part number of grooved pin: 4 166 8024 0

Location of grooved pin:

Between terminals 10 and 11 of the LAL... base, and between terminals 4 and 5 of the LFL... base.

### Start repetition in the event of loss of flame

By removing link «B» on the underside of the unit, the LOK16... can be switched to start repetition in the event of loss of flame during operation.

In that case, the wire link must be cut off completely.

However, it must be checked whether this is in compliance with national standards and regulations.

## Installation notes

---

- Always run the high-voltage ignition cables separately while observing the greatest possible distance to the unit and to other cables
- Neutral conductors must not be interchanged

## Electrical connection of flame detectors

---

It is important to achieve practically disturbance- and loss-free signal transmission:

- Never run the detector cable together with other cables
  - Line capacitance reduces the magnitude of the flame signal
  - Use a separate cable
- Observe the permissible detector cable lengths (refer to «Technical data»)
- It is not permitted to connect 2 flame detectors QRA53... / QRA55... in parallel
- When using the QRA53... / QRA55..., earthing of terminal 22 is mandatory
- The ionization probe is not protected against electric shock hazard
- Locate the ignition electrode and ionization probe such that the ignition spark cannot arc over to the ionization probe (risk of electrical overloads)
- Supervision with ionization probe and QRA... flame detector is possible but, for safety reasons, both must not be active at the same time, with the exception of the second safety time «t9». At the end of the second safety time, one of the detected flames must extinguish, e.g. by shutting down the pilot gas valve connected to terminal 17

## Commissioning notes

- Prior to commissioning, check to ensure that wiring is in an orderly state
- When commissioning the plant or when doing maintenance work, make the following safety checks:

	Safety check	Anticipated response
a)	Burner startup with flame detector darkened	Lockout at the end of «TSA»
b)	Burner startup with simulated flame	Lockout after no more than 40 seconds
c)	Burner operation with simulated loss of flame; for that purpose, darken the flame detector in operation and leave it in that state	<b>LOK16...</b> with wire link cut: Start repetition followed by lockout at the end of «TSA» <b>LGK16...</b> and <b>LOK16...</b> with wire link closed: Immediate lockout
d)	Burner startup with response of air pressure switch	Prevention of startup / lockout during «t1»
e)	Burner operation with simulated air pressure failure	Immediate lockout

## Standards and certificates



Conformity to EEC directives

- Electromagnetic compatibility EMC (immunity) 89 / 336 EEC
- Directive for gas appliances 90 / 396 EEC
- Low-voltage directive 73 / 23 EEC



ISO 9001: 2000  
Cert. 00739



ISO 14001: 1996  
Cert. 38233

Identification code to EN 298

F B / M L L X K

Certified with plug-in base and flame detector:

Type reference								
LOK16.140...	---	---	X	X	X	X	X	---
LOK16.250...	---	---	X	X	X	X	X	---
LOK16.650...	---	---	X	X	X	X	X	---
LGK16.122...	X	X	X	---	---	---	X	X
LGK16.133A17	---	X	---	---	---	---	X	X
LGK16.133A27	X	X	X	---	---	---	X	X
LGK16.322...	X	X	X	---	---	---	X	X
LGK16.333...	X	X	X	---	---	---	X	X
LGK16.335...	X	X	X	---	---	---	X	X
LGK16.622...	X	X	X	---	---	---	X	X
LGK16.635...	X	X	X	---	---	---	X	X

## Service notes

- Each time a unit has been replaced, check to ensure that wiring is in an orderly state. Make the safety check in accordance with section «Commissioning notes»
- The KF8832 flame detector current measuring device must not be used in continuous operation

## Disposal notes

---



The unit contains electrical and electronic components and must not be disposed of together with household waste.  
Local and currently valid legislation must be observed.

## Mechanical design

---

LGK16... / LOK16...

- Plug-in design
- Exchangeable unit fuse (including spare fuse)

Housing

- Made of impact-proof and heat-resistant black plastic
- Lockout reset button with viewing window; located behind it are:
  - The lockout warning lamp
  - The lockout indicator
    - coupled to the spindle of the sequence switch
    - visible in the transparent lockout reset button
    - uses easy-to-remember symbols to indicate the type of fault and the point in time lockout occurred

## Type summary

Switching times are given in the order of the startup sequence, valid for 50 Hz mains frequency. At 60 Hz, the times are about 20 % shorter. The type references apply to burner controls operating on AC 230 V, 50...60 Hz.

\* For burner controls operating on AC 100...110 V, 50...60 Hz, the last 2 digits of the type reference read «17» in place of «27».

### LOK16...

For flame supervision with a selenium photocell detector RAR7... or RAR8... for oil burners				Times
Preferred use:				
Flash-steam generators	Universal application	Medium- or heavy-oil burners		
LOK16.140A27*	LOK16.250A27*	LOK16.650A27*		
t1	10 s	22 s	66 s	Prepurge time with air damper fully open
TSA	4 s	5 s	5 s	Safety time or first safety time with burners using a pilot burner
TSA'	---	---	---	Safety time or first safety time with burners using a pilot burner
t3	2 s	2.5 s	2.5 s	Preignition time
t3'	From startup command (with air pressure supervision: from receipt of air pressure signal)			Long preignition time
t3n	10 s	15 s	15 s	Postignition time (ignition transformer connected to terminal 15)
t4	8 s	7.5 s	7.5 s	Interval between start of «TSA» or «TSA'» and release of valve at terminal 19
t4'	---	---	---	Interval between start of «TSA» or «TSA'» and release of valve at terminal 19
t5	4 s	7.5 s	7.5 s	Interval between end of «t4» or «t4'» and release of load controller or valve at terminal 20
t6	10 s	15 s	15 s	Postpurge time (identical to permissible afterburn time «t13»)
t7	2 s	2.5 s	2.5 s	Switch-on delay of fan motor «M2»
t8	30 s	47 s	91 s	Duration of startup without «t11» and «t12»
t9	---	---	---	Second safety time with burners using a pilot burner
t10	6 s	10 s	10 s	Interval from startup to the beginning of the air pressure check
t11	Optional			Air damper running time to the fully open position
t12	Optional			Air damper running time to the low-fire position
t13	10 s	15 s	15 s	Permissible afterburn time
t16	4 s	5 s	5 s	Interval from startup to the open command for the air damper
t20	32 s	34.5 s	12.5 s	Interval to self-shutdown of the sequence switch

### LGK16...

For flame supervision with flame detector QRA53... / QRA55... or ionization probe							
	Preferred use:			D, A	GB	F, I	B, NL
	Flash-steam generators	Flash-steam generators	D (also suited for direct-fired air heaters), F				
	LGK16.122A27*	LGK16.133A27	LGK16.322A27*	LGK16.333A27*	LGK16.335A27*	LGK16.622A27*	LGK16.635A27*
t1	10 s	9 s	35.5 s	31.5 s	37 s	65 s	66 s
TSA	2 s	3 s	2 s	3 s	2.5 s	2 s	2.5 s
TSA'	2 s	3 s	2 s	3 s	5 s	2 s	5 s
t3	4 s	3 s	4 s	6 s	5 s	4 s	5 s
t3'	4 s	---	4 s	6 s	2.5 s	4 s	2.5 s
t3n	---	---	---	---	---	---	---
t4	6 s	6 s	10 s	11.5 s	12.5 s	10 s	12.5 s
t4'	6 s	---	10 s	11.5 s	15 s	10 s	15 s
t5	4 s	3 s	10 s	11.5 s	12.5 s	10 s	12.5 s
t6	10 s	14.5 s	12 s	17 s	15 s	12 s	15 s
t7	2 s	3 s	2 s	3 s	2.5 s	2 s	2.5 s
t8	30 s	29 s	65 s	69 s	74 s	95 s	103 s
t9	2 s	3 s	2 s	3 s	5 s	2 s	5 s
t10	6 s	6 s	8 s	11.5 s	10 s	8 s	10 s
t11	Optional						
t12	Optional						
t13	10 s	14.5 s	12 s	17 s	15 s	12 s	15 s
t16	4 s	3 s	4 s	6 s	5 s	4 s	5 s
t20	32 s	60 s	---	26 s	22 s	---	---

## Ordering

### Oil burner controls, without plug-in base

(plug-in base not included in delivery, must be ordered as a separate item)

For AC 230 V*	Control sequence and connection diagram like	Preferred use
<b>LOK16.140A27*</b>	LAL2.14	Flash-steam generators
<b>LOK16.250A27*</b>	LAL2.25	Universal application
<b>LOK16.650A27*</b>	LAL2.65	Heavy-oil burners

\* For burner controls operating on AC 100...110 V, 50...60 Hz, the last 2 digits of the type reference read «17» in place of «27»

#### Connection accessories for medium-capacity burner controls see Data Sheet N7230

- Plug-in base **AGM16** with Pg11 thread for cable entry glands
- Plug-in base **AGM16.1** with M16 thread for cable entry glands

#### Flame detectors

- Selenium photocell detectors **RAR...** see Data Sheet N7713

### Gas burner controls, without plug-in base

(plug-in base not included in delivery, must be ordered as a separate item)

For AC 230 V*	Control sequence and connection diagram like	Preferred use
<b>LGK16.122A27*</b>	LFL1.122	Flash-steam generators
<b>LGK16.133A27</b>	LFL1.133	Flash-steam generators
<b>LGK16.322A27*</b>	LFL1.322	D (also suited for direct-fired air heaters), F
<b>LGK16.333A27*</b>	LFL1.333	D, A
<b>LGK16.335A27*</b>	LFL1.335	GB
<b>LGK16.622A27*</b>	LFL1.622	I, F
<b>LGK16.635A27*</b>	LFL1.635	B, NL

\* For burner controls operating on AC 100...110 V, 50...60 Hz, the last 2 digits of the type reference read «17» in place of «27»

#### Connection accessories for medium-capacity burner controls see Data Sheet N7230

- Plug-in base **AGM17** with Pg11 thread for cable entry glands
- Plug-in base **AGM17.1** with M16 thread for cable entry glands

#### Flame detectors

- Flame detectors **QRA53... / QRA55...** see Data Sheet N7712
- **ionization probe** to be supplied by thirds



#### Flame detector current measuring device

**KF8832**

- For detector current measurements with QRA53..., QRA55... , recommended up to series C
- Not suited for continuous operation

## Technical data

General unit data LOK16... / LGK16...	Mains voltage	AC 220 V -15 %...AC 240 V +10 % AC 100 V -15 %...AC 110 V +10 %
	Mains frequency	50...60 Hz $\pm 6$ %
	Unit fuse	T6,3H250V to DIN EN 60 127
	Primary fuse (external)	max. 16 A (slow)
	Weight	approx. 1000 g
	Power consumption	approx. 3.5 VA
	Mounting position	optional
	Degree of protection	IP 40, (to be ensured through mounting) with the exception of the connection area (terminal base)
	Safety class	II
	Perm. input current at terminal 1	max. 5 A to VDE 0660 AC3
	Perm. Current load of control terminals	max. 4 A to VDE 0660 AC3
	Required switching capacity of switching devices	
	- Between terminals 4 and 5, 4 and 12	1 A, AC 250 V
	- Between terminals 4 and 14	depending on loading of terminals 15, 16, 18, 19 (LGK16...: 16...19), min. 1 A, AC 250 V
	Environmental conditions	<b>Storage</b>
Climatic conditions		class 1K3
Mechanical conditions		class 1M2
Temperature range		-20...+60 °C
Humidity		< 95 % r.h.
<b>Transport</b>		DIN EN 60 721-3-2
Climatic conditions		class 2K3
Mechanical conditions		class 2M2
Temperature range		-20...+60 °C
Humidity		< 95 % r.h.
<b>Operation</b>		DIN EN 60 721-3-3
Climatic conditions		class 3K3
Mechanical conditions		class 3M3
Temperature range		-20...+60 °C
Humidity		< 95 % r.h.



**Condensation, formation of ice and ingress of water are not permitted!**

Flame supervision

	LOK16...	LGK16...		
	RAR...	QRA5x.C...	QRA5x.D...	ionization probe
Operating voltage (Terminal 23 or 24)	< DC 1 V $\pm 10$ %	AC 280 V <sup>1)</sup> $\pm 10$ %	AC 280 V <sup>1)</sup> $\pm 10$ %	AC 245 V <sup>1)</sup> $\pm 10$ %
Minimum detector current required	DC 6 $\mu$ A	DC 35 $\mu$ A	DC 120 $\mu$ A	DC 12 $\mu$ A
Maximum possible detector current	DC 25 $\mu$ A	DC 50 $\mu$ A	DC 270 $\mu$ A	DC 100 $\mu$ A
Short-circuit current	---	---	---	approx. AC 300 $\mu$ A
Maximum length of detector cable (laid separately)	100 m	<sup>2)</sup>	<sup>2)</sup>	60 m <sup>3)</sup>

- AC voltage, measured with no detector current at AC 230 V mains voltage. Internal resistance of measuring instrument 10 M $\Omega$ . The shutter of the flame detector QRA53... / QRA55... is powered by mains voltage
- Detector cable laid in a minimum distance of 5 cm from other mains carrying cable:
    - As a multiple cable **max. 50 m**
    - With 5 single wires **max. 70 m**
  - With a shielded 3-core control cable to terminals 3, 4 and 5 of the flame detector QRA53... / QRA55... and standard mains cable to terminals 1 and 2 **max. 15 m**
  - With 2 shielded single-core coaxial cables ( $\leq 45$  pF / m, e.g. RG 62) to terminals 3 and 4 of the flame detector QRA53... / QRA55... and standard mains cable to terminals 1, 2 and 5 **max. 60 m**
  - If possible, shielding should be earthed at both ends
- Longer cable distances are permitted when connecting low-capacitance detector cables to terminal 24 of the burner control (especially against earthed wires!)



## Detector current measurement

LOK16... / RAR...

The measuring device must be connected between the detector and terminal 22 (+pole to terminal 22).

LGK16... / QRA53... /  
QRA55...

Use the KF8832 measuring device (not suited for continuous operation).  
There is no self-checking while measurements are made.  
The KF8832 is not required when using the QRA5x.D...

LGK16... / detector  
electrode

The measuring device must be connected between terminal 24 and the detector electrode (+pole to terminal 24).

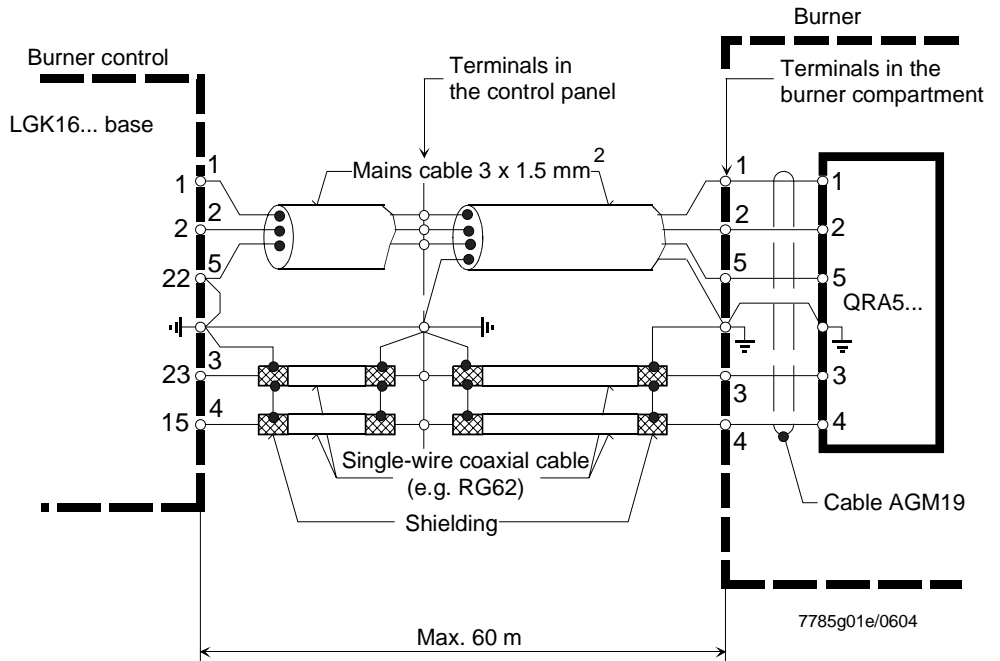

With QRA5x.C...

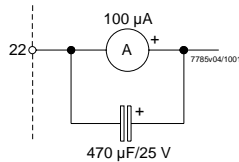

With QRA5x.D...

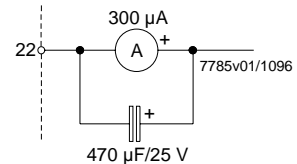

With RAR...

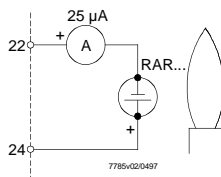

With ionization

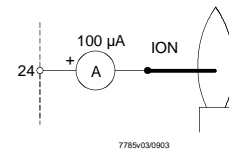

### Legend

A            Ammeter  
RAR...     Selenium photocell detector  
ION         Ionization probe

## Function

### Principle of self-supervision

In contrast to conventional amplifiers, the signal delivered by the flame detector is handled dynamically and not statically. The flame detector signal is converted to a sequence of control pulses and then fed to the flame relay circuit. The latter is designed such that the flame relay can only be energized by a flame signal of the described form. If the pulses change due to a faulty detector or faulty detector cables, the relay will be deenergized and the burner control triggers the required safety actions. In the case of UV supervision, it must also be ensured that self-ignition of the UV tube (e.g. due to aging) does not simulate a flame signal. For that reason, incident radiation at the UV cell is periodically interrupted by a shutter. In addition to the self-checking facility, the flame signal circuit is subjected to a functional test during the prepurge time. If it does not operate correctly, the startup sequence will be aborted or lockout initiated. Furthermore, if mains voltage drops to a level where safe operation of the burner control is no longer ensured, the burner will automatically shut down. When mains voltage returns to the normal level, the burner control repeats the startup sequence. If the detector signals are only slightly above the minimum levels, such mains voltage fluctuations can also give rise to burner lockout however.

### Prerequisites for burner startup

- The burner control is reset and in the start position (terminals 11 and 12 must receive power)
- The air damper is closed. End switch «z» for the fully closed position must feed power from terminal 11 to terminal 8
- All control contacts between terminals 12 and 5 (limit thermostat, control thermostat, etc.) must be closed

#### A Start

When «R» closes, the burner control's sequence switch starts running. At the same time, the fan motor connected to terminal 6 (only prepurging) receives power and, on completion of «t7», the fan motor or flue gas fan at terminal 7 (pre- and postpurging) also receives power. On completion of «t16», the control command to open the air damper is given via terminal 9. During the running time of the motor, the sequence switch does not operate, as terminal 8, via which the motor of the sequence switch first receives power, is not live during that period of time. The sequence switch starts again and programs only after the air damper is fully open and end switch «a» has changed over to feed power to terminal 8.

#### t1 Prepurge time with air damper fully open (nominal amount of combustion air)

Shortly after the start of the prepurge time, air pressure switch «LP» must change over, thus interrupting the current path between terminals 4 and 13. Otherwise, the burner control would go to lockout (start of air pressure check). At the same time, terminal 14 must be live since this current path is used to power the ignition transformer and the fuel valves.

t3' With the LOK16..., an ignition transformer connected to terminal 15 is therefore switched on at this point in time (long preignition). If there is no «LP», the ignition transformer receives power already with the start command. On completion of the prepurge time, the burner control via terminal 10 drives the air damper into the low-fire position, which is determined by the changeover point of auxiliary switch «m». During the positioning time, the sequence switch stops again until terminal 8 receives power from «m».

#### t5 Interval

On completion of «t5», terminal 20 receives power. At the same time, control outputs 9 to 11 and input 8 are galvanically separated from the unit's control section, so that the latter is protected against reverse voltages from the load control circuit. The startup sequence of the burner control ends with the release of load controller «LR» at terminal 20. The sequence switch switches itself automatically off, depending on the time variant used, either immediately or after some so-called «idle steps», that is, without changing the contact positions.

## Function (cont'd)

Expanding flame burners with **LOK16...** or **LGK16...**

**t3 Short preignition time**; followed by fuel release via terminal 18.

### **TSA Safety time** (part load)

On completion of the safety time latest, a flame signal must be present at the input of the flame signal amplifier, or else the burner control will initiate lockout.

### **Only with LOK16...:**

**t3n Postignition time** (provided the ignition transformer is connected to terminal 15).

**t4 Interval** until the fuel valve is released via terminal 19.

Interrupted pilot burner with LGK16...

(Burners using a pilot burner)

**t3 / t3' Short preignition time**; followed by release of fuel for the pilot burner via terminal 17.

### **TSA / TSA' First safety time** (ignition load)

On completion of the safety time latest, a flame signal must be present at the input of the flame signal amplifier, or else the burner control will initiate lockout.

**t4 / t4' Interval** until the fuel valve at terminal 19 is released (start load of the main burner). Times «TSA'», «t3'» and «t4'» are only programmed by burner controls type **LGK16.335...** and **LGK16.635...**

### **t9 Second safety time**

On completion of the safety time, the main burner must have been ignited by the pilot burner, since the pilot gas valve is closed on completion of «t9».

## **B Operating position of the burner**

### **B-C Burner operation** (generation of heat)

During burner operation, the load controller drives the air damper to the nominal load or low-fire position, depending on heat demand. Here, the nominal load is released by auxiliary switch «v» in the air damper actuator.

### **C Controlled shutdown by «R»**

In the case of controlled shutdown, the fuel valves are immediately closed and, at the same time, the sequence switch starts again to program the postpurge time.

**t6 Postpurge time** (postpurging with fan «M2» connected to terminal 7).

Shortly after the start of the postpurge time, voltage at terminal 10 is reinstated, so that the air damper is driven into the «MIN» position. The full closing of the air damper starts only shortly before the completion of the postpurge time initiated by the control signal on terminal 11, which also remains live during the following burner off period.

### **t13 Permissible afterburn time**

During «t13», the flame signal input may still receive a flame signal  
→ No lockout

### **D-A End of control sequence** (= start position)

When, on completion of «t6», the sequence switch has reset the control contacts to their start positions, thereby switching itself off, the detector and flame simulation test is started again. However, during the burner off period, lockout can occur only if the faulty flame signal lasts a few seconds. Hence, short ignition pulses of the UV detector caused by cosmic radiation do not initiate lockout.

## Control sequence in the event of fault and indication of lockout

---

In case of any disturbance, the supply of fuel will immediately be interrupted. At the same time, the sequence switch stops and thus the lockout indicator also.

The symbol appearing above the reading mark indicates the kind of fault:

- ◀ No start, because one of the contacts is not closed (also refer to «Prerequisites for burner startup») or lockout during or after completion of the control sequence due to extraneous light (e.g. flame not extinguished, leaking fuel valves, faulty flame supervision circuit, or similar).
- ▲ Abortion of startup sequence, because end switch «a» has not fed the OPEN signal to terminal 8. Terminals 6, 7 and 14 and, in case **LOK16...** is used, terminal 15, also remain live until the fault is corrected.
- P Lockout, because the air pressure signal has not been received at the start of the air pressure check.
- Lockout due to a fault in the flame supervision circuit.
- ▼ Abortion of startup sequence, because auxiliary switch «m» has not delivered the positioning signal for the low-fire position to terminal 8. Terminals 6, 7 and 14 and, in case **LOK16...** is used, terminal 15, also remain live until the fault is corrected.
- 1 Lockout, because no flame signal has been received on completion of the (first) safety time.
- 2 **Only with LGK16...:**  
Lockout, because no flame signal has been received on completion of the second safety time (flame signal of the main flame with interrupted pilot burners).
- I Lockout, because the flame signal has been lost during burner operation or air pressure failure has occurred.

### **Only with LOK16...:**

If wire link «B» was cut off and the flame is lost during burner operation, the burner control programs a repetition of the startup sequence with the full program.

Lockout indication

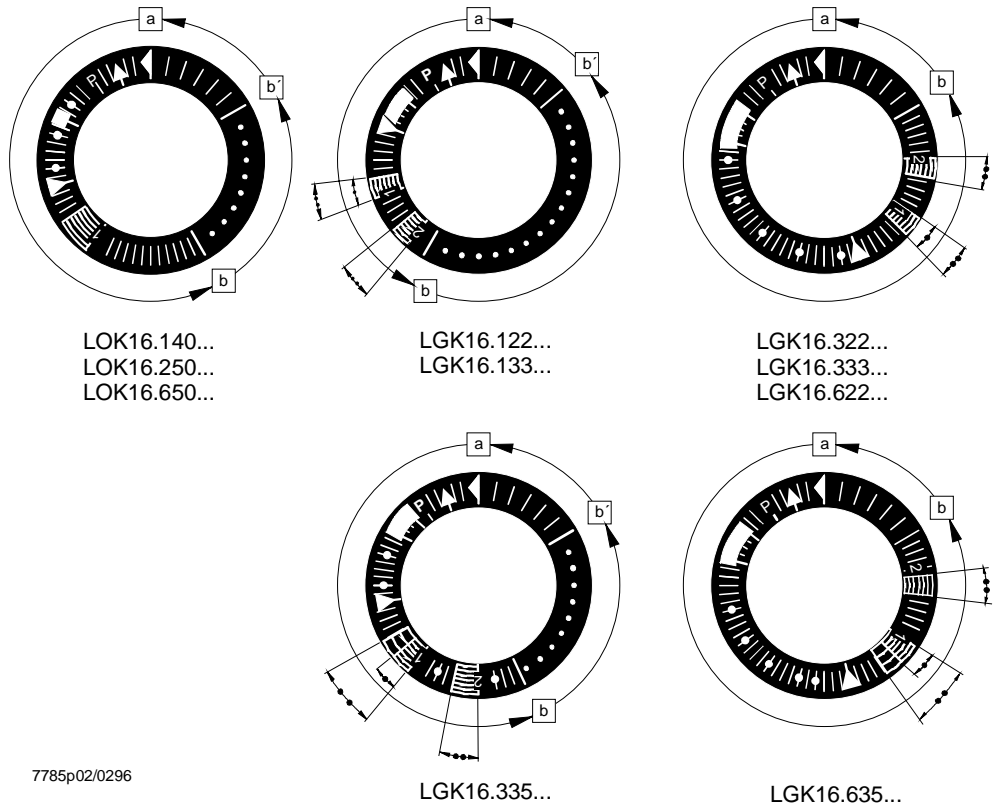

a-b Startup sequence

b-b' With certain time variants:  
«Idle steps» of the sequence switch up to the self-shutdown after burner startup  
(b' = operating position of the sequence switch)

b(b')-a Postpurge sequence after controlled shutdown.  
In start position «a», the sequence switch switches itself automatically off or immediately initiates another burner startup (e.g. after a fault has been corrected)

- Duration of safety time with expanding flame burners
- Duration of safety times with interrupted pilot burners

When lockout has occurred, the burner control can immediately be reset. After resetting, and also after correction of a fault, which resulted in shutdown, or after a mains failure, the sequence switch always runs to its start position, whereby only terminals 7, 9, 10 and 11 receive power in accordance with the control sequence. It is only then that the burner control programs a burner restart.

Note: Do not press the lockout reset button for more than 10 seconds.

Connection diagrams (for circuitry variants, refer to «Connection examples»)

LOK16...

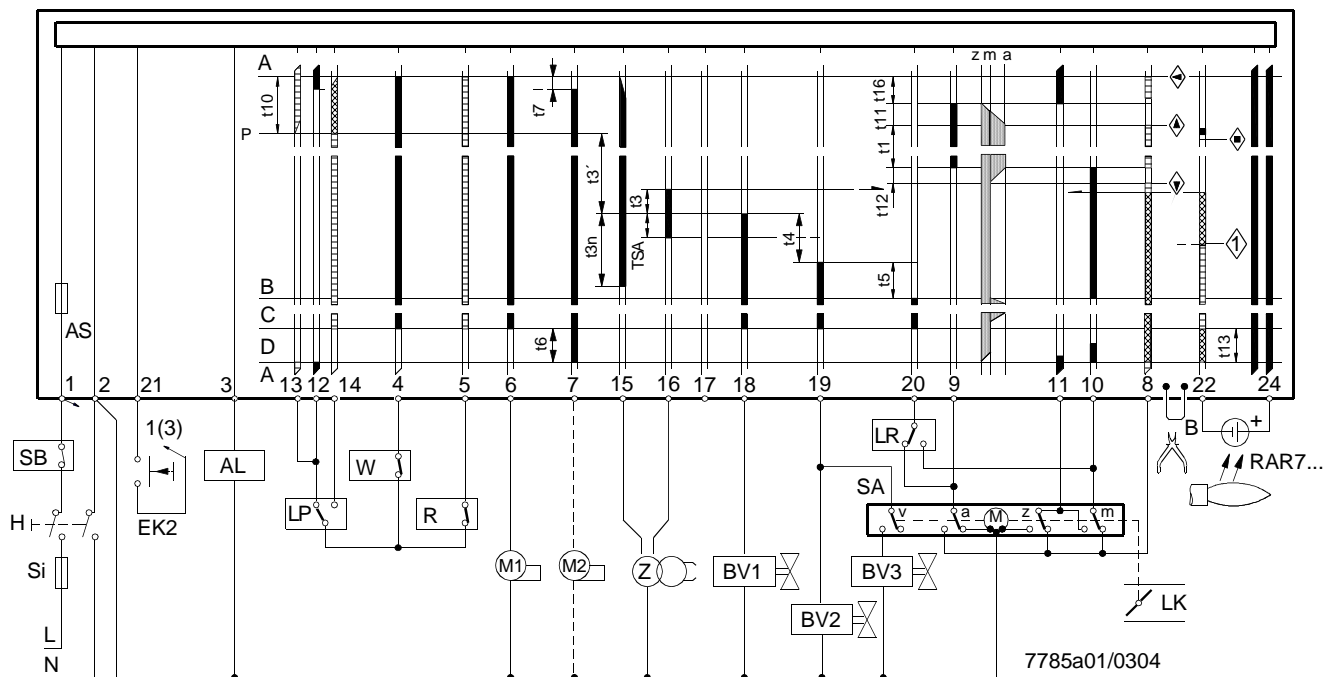

 Do not press lockout reset button «EK...» for more than 10 seconds!

LGK16...

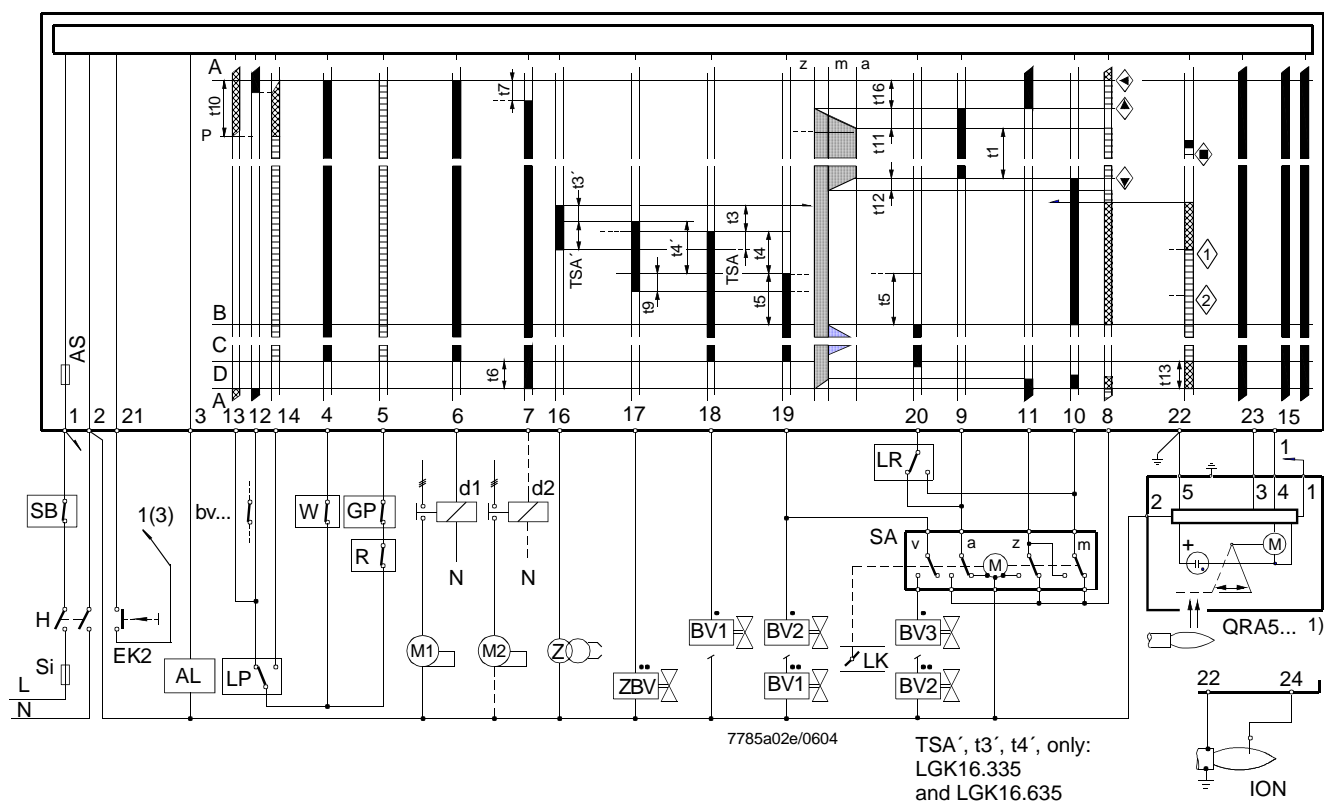

 Do not press lockout reset button «EK...» for more than 10 seconds!

1) When used in connection with QRA53... / QRA55..., earthing of terminal 22 is mandatory!

## Legend

a	Changeover end switch for air damper's fully open position	m	Auxiliary changeover switch for the air damper's MIN position
AL	Remote lockout warning device (alarm)	M...	Fan or burner motor
AR	Main relay (load relay) with «ar» contacts	NTC	Resistor with negative temperature coefficient
AS	Unit fuse	QRA...	UV detector
B	Wire link (on the burner control's base)	R	Control thermostat or pressurestat
BR	Lockout relay with «br» contacts	RAR...	Selenium photocell detector
BV...	Fuel valve	SA	Air damper actuator
bv...	Auxiliary contact in the valve actuator for the fully closed position check	SB	Safety limit thermostat
d...	Contact or relay	Si	External fuse
EK...	Lockout reset button	SM	Synchronous motor of sequence switch
ION	Ionization probe	v	In the air damper actuator: Auxiliary changeover switch for release of fuel as a function of the air damper position
FR	Flame relay with «fr» contacts	V	Flame signal amplifier
FS	Flame signal	W	Limit thermostat or pressure switch
GP	Gas pressure switch	z	In the air damper actuator: End switch for the air damper's fully closed position
H	Mains isolator	Z	Ignition transformer
L...	Lockout warning lamp	ZBV	Pilot valve
LK	Air damper		
LP	Air pressure switch	A	Startup
LR	Load controller	B	Operating position
		C	Controlled shutdown
		D	End of control sequence
•	Valid for expanding flame burners		
••	Valid for burners with a pilot burner which is shut down after the main burner has ignited		



Control signals delivered by the burner control



Permissible input signals



Required input signals:

If these signals are not present at the points in time marked by symbols or during the shaded periods of time, the burner control will interrupt the startup sequence or initiate lockout

Lockout indication positions when there is no input signal (refer to «Control sequence in the event of faults»):

◀	No start	1	Lockout (no flame)
▲	Abortion of startup sequence	2	Lockout (no flame)
▼	Abortion of startup sequence	P	Lockout (no air pressure)
■	Lockout (fault in the flame supervision circuit)		

### Time table

t1	Prepurge time with air damper fully open	t7	Switch-on delay for fan motor M2
TSA	Safety time or first safety time with burners using a pilot burner	t8	Duration of startup sequence excluding «t11» and «t12»
TSA'	Safety time or first safety time with burners using a pilot burner	t9	Second safety time with burners using a pilot burner
t3	Preignition time	t10	Interval from the start to the beginning of the air pressure check
t3'	Preignition time	t11	Running time of air damper into the fully open position
t3n	Postignition time (ignition transformer connected to terminal 15)	t12	Running time of air damper into the low-fire position
t4	Interval from the start of «TSA» or «TSA'» to the valve connected to terminal 19	t13	Permissible afterburn time
t4'	Interval from the start of «TSA» or «TSA'» to the release of the valve connected to terminal 19	t16	Interval from the start to the OPEN command for the air damper
t5	Interval from the end of «t4» or «t4'» to the release of the load controller or valve at terminal 20	t20	Interval to the self-shutdown of the sequence switch
t6	Postpurge time (identical with the permissible afterburn time «t13»)	max.	Safety time in the event of loss of flame during operation

\* Times TSA', t3' and t4' are only programmed by burner controls LGK16.335... and LGK16.635...

Connection diagrams

LGK16...

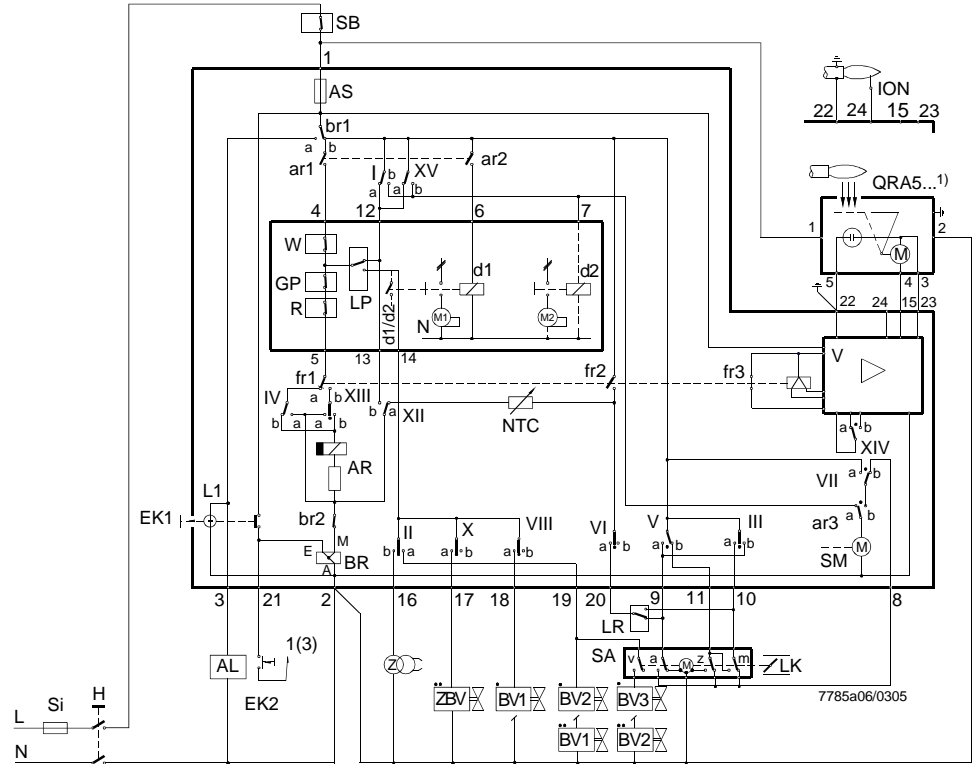

Do not press lockout reset button «EK...» for more than 10 seconds!

1) When used in connection with QRA53... / QRA55..., earthing of terminal 22 is mandatory!

LOK16...

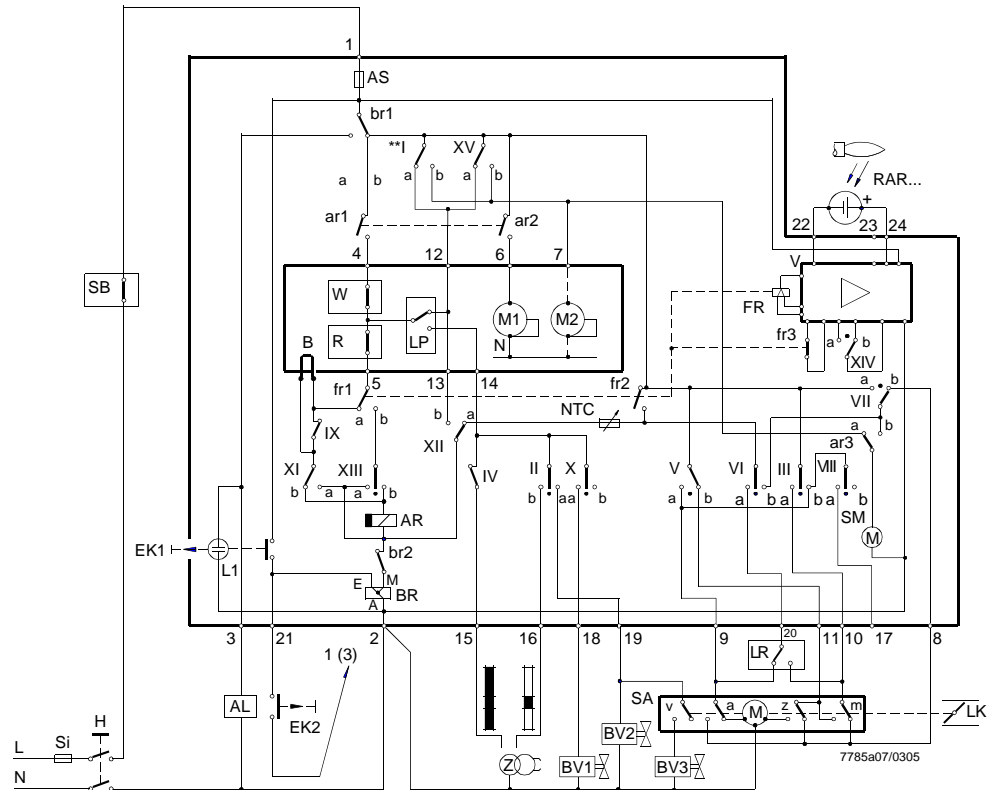

Do not press lockout reset button «EK...» for more than 10 seconds!



**Program sequence**

LGK16...

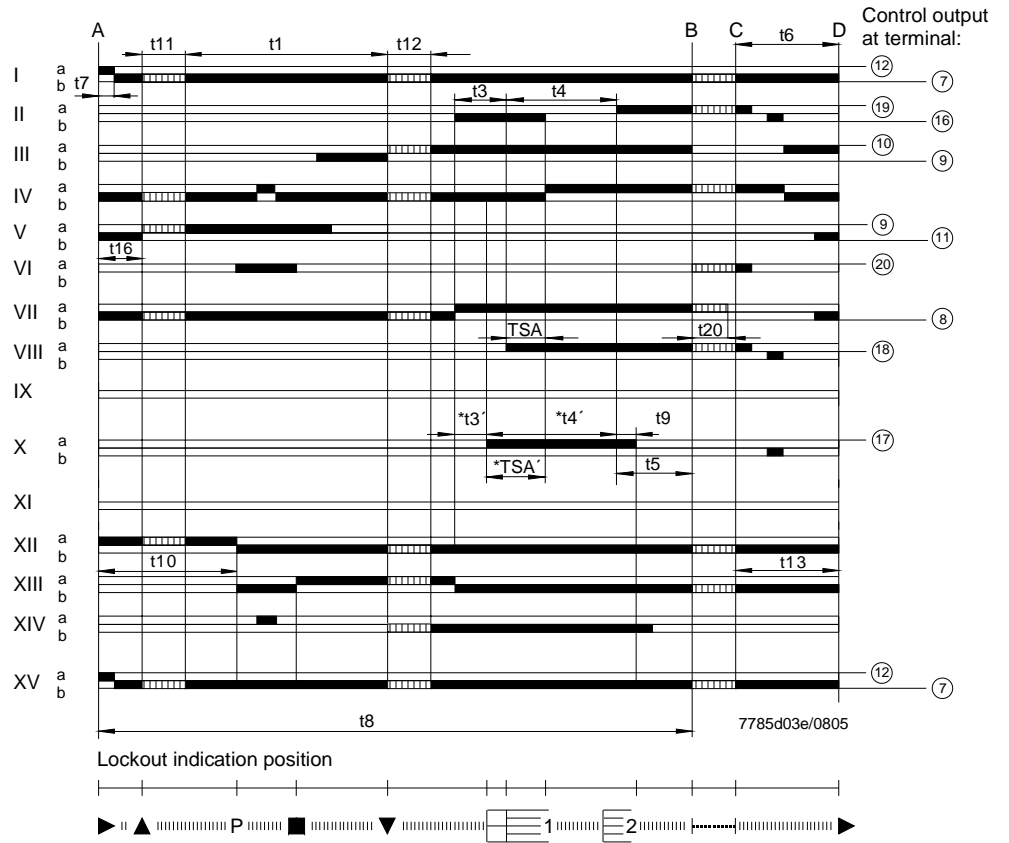

\* Times TSA', t3' and t4' are only programmed by burner controls LGK16.335... and LGK16.635...

LOK16...

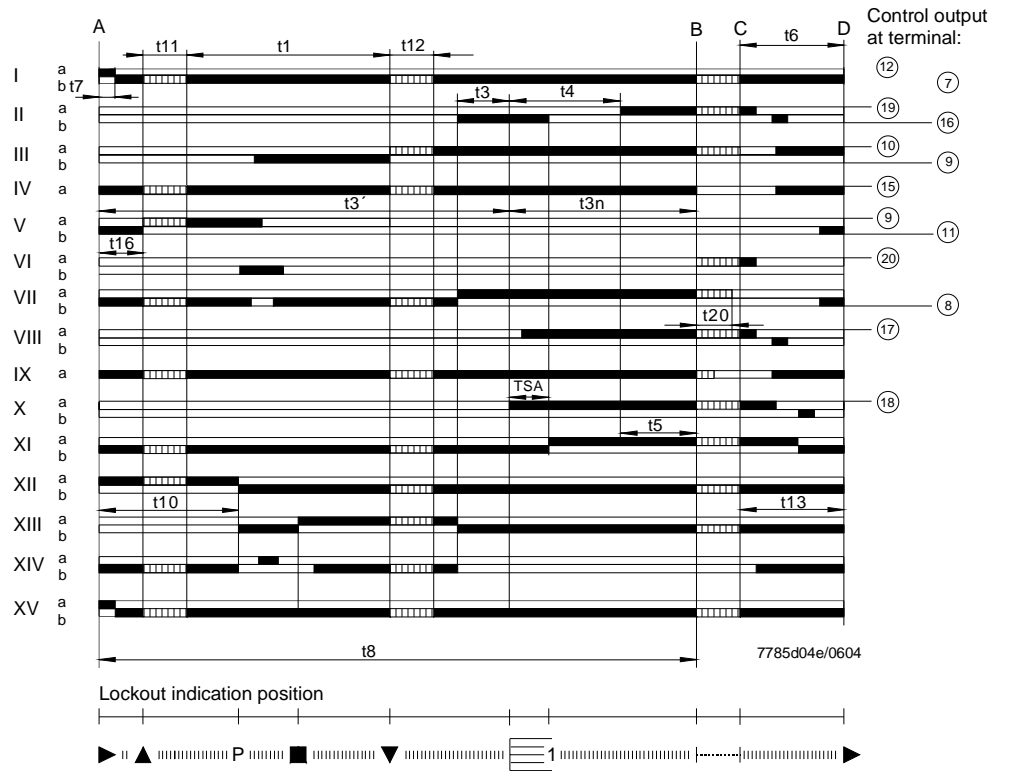

**Connection examples**

LGK16...

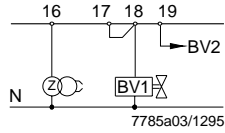

Doubling of safety time with expanding flame burners when using burner control LGK16.335... or LGK16.635...

By connecting terminals 17 and 18, the safety time is doubled and the preignition time reduced by 50 %. Before using this circuit, it must be ensured that the longer safety time is in compliance with national standards and regulations!

LOK16...

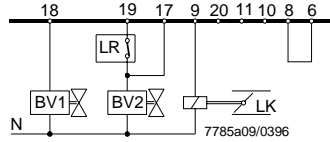

Control of the air damper actuator during operation by feeding control signals to terminal 17

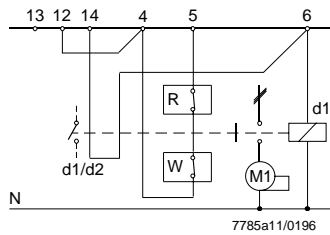

Wiring required for operation without air pressure supervision

If an auxiliary contact of the fan contactor is included in the circuit as shown in the diagram, ignition and fuel release are possible only when the contact is closed.

LOK16... / LGK16...

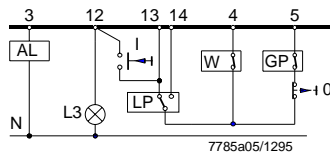

Semiautomatic startup

The burner is switched on manually by pressing button «I». Then, the burner control programs the startup sequence and flame supervision.

The burner is switched off manually by pressing button «0», or automatically by the limit thermostat or pressure switch «W», or by gas pressure switch «GP». «L3» indicates when the burner control is ready to be started; it extinguishes shortly after the burner is switched on.

For the other connections, refer to the connection diagrams.

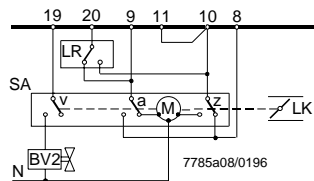

Connection of air damper actuators without changeover end switch for the fully closed position.

«Z» is set to low-fire

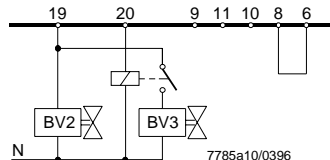

Control of a fuel valve by terminal 20 in the case of burners without air damper or with an air damper not controlled by the burner control.

The relay is not required if the valve connected to terminal 20 is hydraulically series-connected to a valve controlled by terminal 18 or 19. If no air damper actuator is used, terminal 8 must be connected to terminal 6.

## Program sequence

Expanding flame burners (burners without a pilot burner), controlled and supervised by **LOK16...** or **LGK16...**  
 Air damper in low-fire position during burner off times (min.).

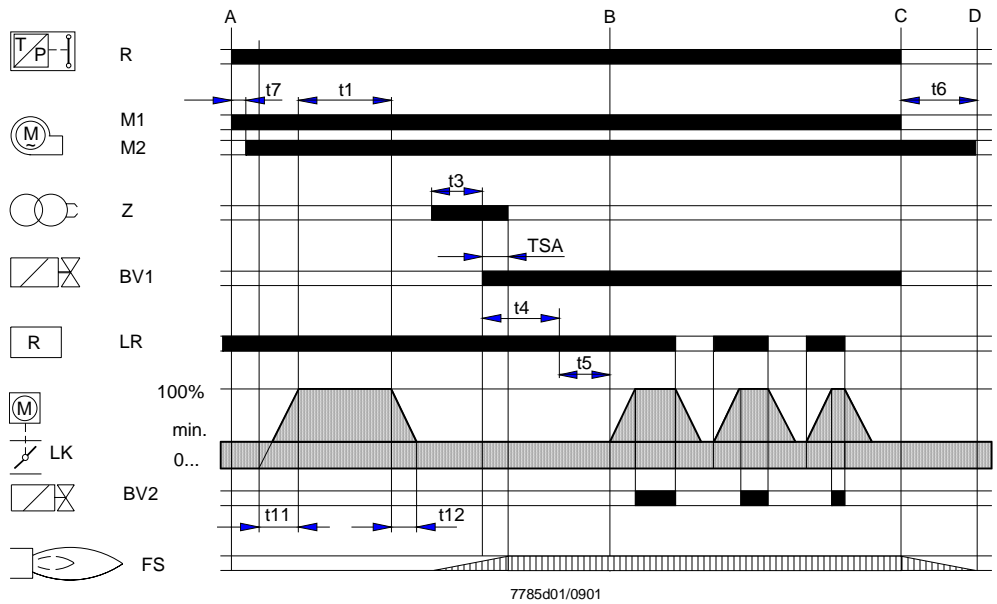

Interrupted pilot burners (burners with pilot burner), controlled and supervised by **LGK16.335** or **LGK16.635**, for example.  
 The other types of burner controls of the LGK16... range program the times «TSA», «t3», «t4» and «t9» for the pilot burner.

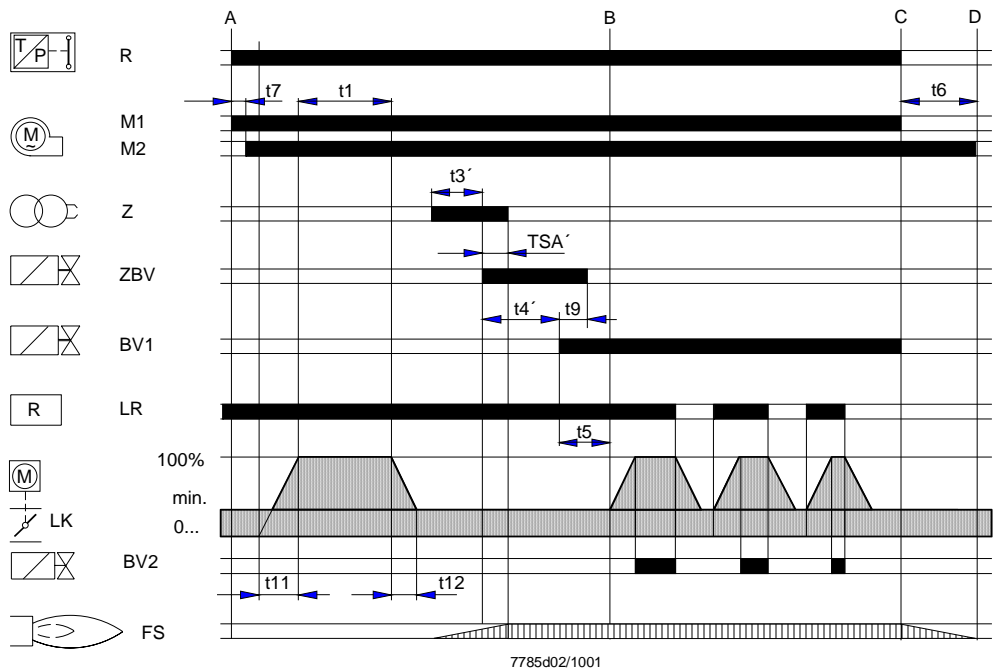

## Dimensions

Dimensions in mm

LOK16... / LGK16...



Plug-in base AGM17 / AGM17.1

